

GLOBAL
RE-LEAF

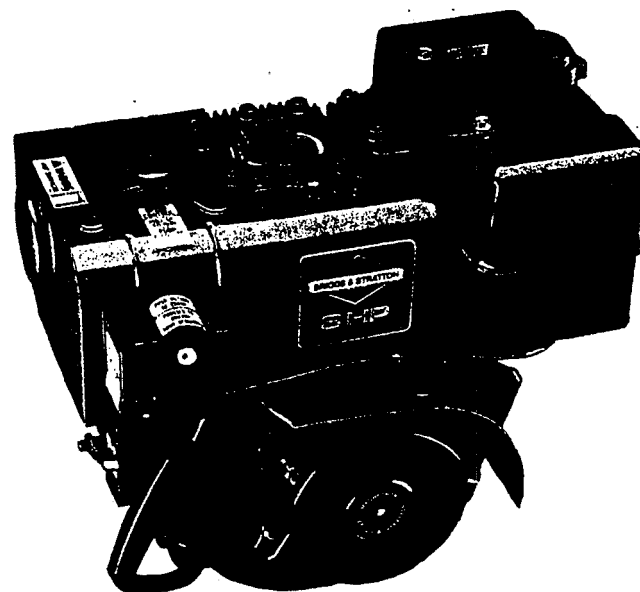

*Operating and Maintenance Instructions for
Sno/Gard Model Series 170400, 190400*

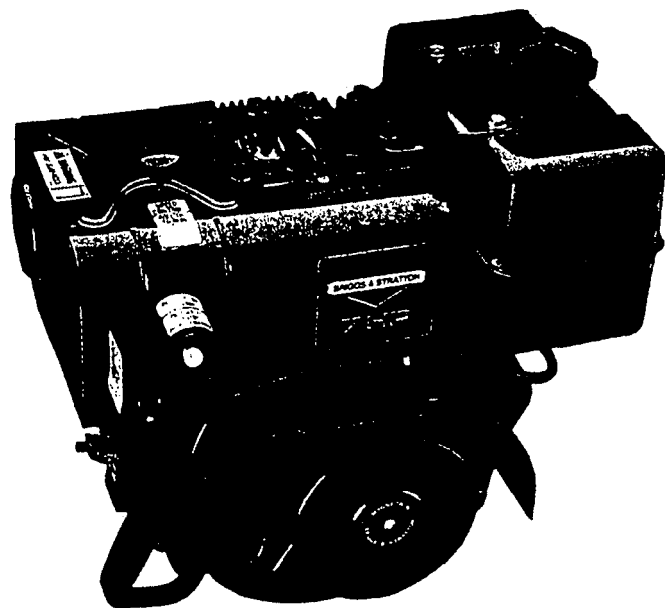

Briggs & Stratton Corporation
Milwaukee, Wisconsin 53201

© Copyright 1990 by Briggs & Stratton Corporation

FORM NO. 270617-7/94
PRINTED IN U.S.A.

IMPORTANT SAFETY INFORMATION AND INSTRUCTIONS FOR ENGINE SELECTION ENGINE INSTALLATION ENGINE OPERATION

In the USA and Canada,
our 24 hour hotline is:

18002333723

Briggs & Stratton Corporation
Milwaukee, Wisconsin 53201

www.briggsandstratton.com

Keep these instructions for future reference.





Before installing and operating this engine read and observe all warnings, cautions and instructions on both sides of this sheet, on the engine, and in the operating & maintenance instructions.

NOTE: This sheet of instructions and safety information is not meant to cover all possible conditions and situations that may occur. Read entire Operating & Maintenance Instructions for this engine AND the instructions for the equipment this engine powers. Failure to follow instructions and safety information could result in serious injury or death.

The safety alert symbol () is used to identify safety information about hazards that can result in personal injury.

A signal word (DANGER, WARNING, or CAUTION) is used with the alert symbol to indicate the likelihood and the potential severity of injury. In addition, a hazard symbol may be used to represent the type of hazard.

 **DANGER** indicates a hazard which, if not avoided, will result in death or serious injury.

 **WARNING** indicates a hazard which, if not avoided, could result in death or serious injury.

 **CAUTION** indicates a hazard which, if not avoided, might result in minor or moderate injury.

CAUTION, when used **without** the alert symbol, indicates a situation that **could result in damage to the engine.**

HAZARD SYMBOLS AND MEANINGS



Fire



Explosion



Moving Parts



Toxic Fumes



Hot Surface



Shock



Kickback

(OVER)

FORM MS-6445-01/03

ENGINE SELECTION



 WARNING



Failure to select the correct engine could result in fire or explosion.



- Some engines are unique and designed for specific applications or types of equipment. If this engine will be used to build new equipment, contact Briggs & Stratton to ensure that the engine is appropriate for the intended use.
Note: For all Go-karts use only a model 136200 series engine, which offers improved safety and performance.
- Replacement engines should be the same model as the original engine, or be the Briggs & Stratton designated replacement engine. Refer to the Operation & Maintenance Instructions for engine identification information.
Note: For all Go-karts use only a model 136200 series engine, which offers improved safety and performance.
- Do not use Briggs & Stratton engines on 3-wheel All-Terrain Vehicles (ATVs), motor bikes, air craft products, or vehicles intended for use in competitive events. Briggs & Stratton does not approve of or authorize such uses.

ENGINE INSTALLATION



- [1] Do not attempt to install this engine if you do not have the appropriate tools and knowledge of small engine installation procedures. Use only Briggs & Stratton parts. Contact your Authorized Service Dealer for assistance.
- [2] Do not modify the engine in any way without Briggs & Stratton factory approval. Any such modification is at the owner's sole risk.
- [3] If the exhaust system on the old engine was supplied by the equipment manufacturer, you must transfer the exhaust system and related components (original muffler and related pipes, brackets, clamps, and shields) to the new engine. All components must be in good condition.
- [4]



 WARNING	Install muffler (and muffler deflector if used) so outlet points away from operator, fuel tank, and equipment, and so muffler heat will not damage or deform engine and components.
	
- [5]



 WARNING	Ensure all fuel lines and fittings are properly assembled and do not leak. Replacement parts must be the same model as the original.
	
- [6]



 WARNING	Ensure all wiring, including safety switches and engine shut-off components are completely installed and functioning properly.
	
- [7] Set engine speed to equipment manufacturer's specification. Refer to equipment manufacturer's manual. Do not tamper with governor springs, or other parts that will increase engine speed above specification.

- [8]







 WARNING	All engine parts, including fuel cap, spark plug, muffler, air cleaner, and covers and guards for drive components (gears, belts, shafts, couplings, etc.) must be in place before attempting to start engine.
	
- [9]

 WARNING	If engine is installed on walk behind lawn mower, all mower components, including cutting blade, must be correctly installed before attempting to start engine.
	
- [10]

 WARNING	When working on the engine or equipment, remove spark plug wire from spark plug. For electric start, remove negative wire from battery.
	
- [11]

 WARNING	Do not check for spark with spark plug removed. Use Briggs & Stratton spark tester #19368.
	

ENGINE OPERATION

	 WARNING
	When adding fuel:
<p>Turn engine off and let engine cool at least 2 minutes before removing gas cap.</p> <p>Fill fuel tank outdoors or in well-ventilated area. Fill tank to about 1 inch below lowest portion of neck to allow for fuel expansion.</p> <p>Keep gasoline away from sparks, open flames, pilot lights, heat, and other ignition sources.</p>	
	 WARNING
	When starting engine:
<p>Remove all external equipment/engine loads.</p> <p>Wait until spilled fuel is evaporated. Start engine outdoors.</p> <p>Pull cord slowly until resistance is felt, then pull rapidly.</p> <p>If engine floods, set choke to OPEN/RUN, place throttle in FAST and crank until engine starts.</p>	
	 WARNING
	When operating equipment:
<p>Do not tip engine or equipment at angle which causes gasoline to spill.</p> <p>Run engine outdoors. Do not run in enclosed area, even if doors or windows are open.</p> <p>Do not choke carburetor to stop engine.</p>	

In the Interest of Safety



This SAFETY ALERT SYMBOL indicates that THIS MESSAGE involves PERSONAL SAFETY. Words DANGER, WARNING and CAUTION indicate degree of hazard. DEATH, PERSONAL INJURY and/or PROPERTY DAMAGE may occur unless INSTRUCTIONS ARE FOLLOWED CAREFULLY.



You are not ready to operate this engine if you have not read and understood the following safety items. Read this entire owner's manual and the operating instructions of the equipment this engine powers.

The Briggs & Stratton engine you bought with your equipment is made of the finest material in a state-of-the-art manufacturing facility. Please understand that Briggs & Stratton sells engines to original equipment manufacturers. It also sells to others in the distribution chain who may sell to the ultimate consumer, an equipment manufacturer, another distributor or a dealer. As a result, Briggs & Stratton does not necessarily know the application on which the engine will be placed. For that reason, you should carefully read and understand the operating instructions of the equipment on which your engine is placed before you operate it.

You should also understand that there are equipment applications for which Briggs & Stratton does not approve the use of its engines. Briggs & Stratton engines are not to be used on vehicles with less than 4 wheels. They include motor bikes, aircraft products and All Terrain Vehicles. Moreover, Briggs & Stratton does not approve of its engines being used in competitive events. **FOR THAT REASON, BRIGGS & STRATTON ENGINES ARE NOT AUTHORIZED FOR ANY OF THESE APPLICATIONS.** Failure to follow this warning could result in death, serious injury (including paralysis) or property damage.



DO NOT run engine in an enclosed area. (Exhaust gases contain carbon monoxide, an odorless and deadly poison.)
DO NOT place hands or feet near moving or rotating parts.
DO NOT store, spill, or use gasoline near an open flame, nor near an appliance like a stove, furnace, or water heater that uses a pilot light or can create a spark.
DO NOT refuel indoors or in unventilated area.
DO NOT remove fuel tank cap nor fill fuel tank while engine is hot or running. (Allow engine to cool 2 minutes before refueling.)
DO NOT operate engine if gasoline is spilled or when smell of gasoline is present or other explosive conditions exist. (Move equipment away from spill and avoid any ignition until gasoline has evaporated.)
DO NOT transport engine with fuel in tank.
DO NOT choke carburetor to stop engine. (Whenever possible, gradually reduce engine speed before stopping.)
DO NOT tamper with governor springs, links or other parts to increase engine speed. (Run engine at speed set for equipment manufacturer.)



WARNING

DO NOT check for spark with spark plug removed. (Use an approved tester.)
DO NOT crank engine with spark plug removed. (If engine is flooded, place throttle in FAST and crank until engine starts.)
DO NOT strike flywheel with a hammer or hard object as this may cause flywheel to shatter in operation. (Use correct tools to service engine.)
DO NOT operate engine without a muffler. (Inspect periodically and replace if worn or leaking. If engine is equipped with muffler deflector, inspect periodically and, if necessary, replace with correct deflector.)
DO NOT operate engine with an accumulation of grass, leaves or other combustible material in muffler area.
DO NOT use this engine on any forest covered, brush covered, or grass covered unimproved land unless a spark arrester is installed on muffler. (Spark arrester must be maintained in working order by operator.)
DO NOT touch hot muffler, cylinder, or fins which can cause burns.
DO NOT start engine with air cleaner or air cleaner cover removed (or cover over carburetor air intake, if Sno/Gard engine).



- ✓ PREVENT ACCIDENTAL STARTING by removing spark plug wire when servicing engine or equipment. Disconnect negative wire from battery terminal if equipped with electric starting system.
- ✓ KEEP cylinder fins and governor parts free of dirt, grass and other debris which can affect engine speed.
- ✓ PULL starter cord slowly until resistance is felt. Then pull cord rapidly to avoid kickback and prevent hand or arm injury.



WARNING

- ✓ USE fresh gasoline. Stale fuel can gum carburetor and cause leakage.
- ✓ CHECK fuel lines and fittings frequently for cracks or leaks. Replace if necessary.
- ✓ Use only Genuine Briggs & Stratton Parts or their equivalent. Use of replacement parts which are not of equivalent quality may damage the engine.

International Symbols



Safety Alert



Read Owner's Manual

| ○ On Off



Stop



Fuel Shutoff



Fuel



Choke

In the USA and Canada, a 24 hour hot line, 1-800-233-3723, has a menu of pre-recorded messages offering you engine maintenance information.

Before Starting

READ THE OPERATING INSTRUCTIONS OF THE EQUIPMENT THIS ENGINE POWERS

 NOTE: Engine is shipped WITHOUT oil.

4-CYCLE OIL RECOMMENDATIONS

Change and Add Oil According to Chart below.

We recommend the use of a high quality detergent oil classified "For Service SE, SF, SG," such as Briggs & Stratton 30 weight oil, part no. 100005. Detergent oils keep the engine cleaner and retard the formation of gum and varnish deposits. No special additives should be used with recommended oils.

NOTE: DO NOT MIX OIL WITH GASOLINE.

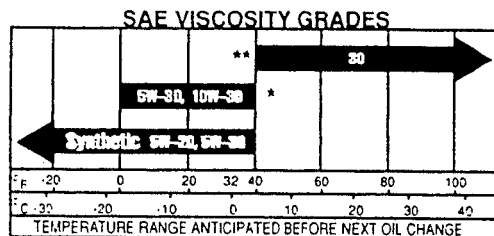

* Air cooled engines run hotter than automotive engines. Use of multi-viscosity oils (10W-30, etc.) above 40° F (4° C) will result in high oil consumption and possible engine damage. Check oil level more frequently if using these types of oils.

** SAE 30 oil, if used below 40° F (4° C), will result in hard starting and possible engine bore damage due to inadequate lubrication.

FILL CRANKCASE WITH OIL:

Place engine level. Clean area around oil fill. Remove oil fill plug or dipstick. **POUR OIL SLOWLY. DO NOT OVER-FILL.** Capacity is approximately 2.75 pints (44 ounces or 1.3 liters).

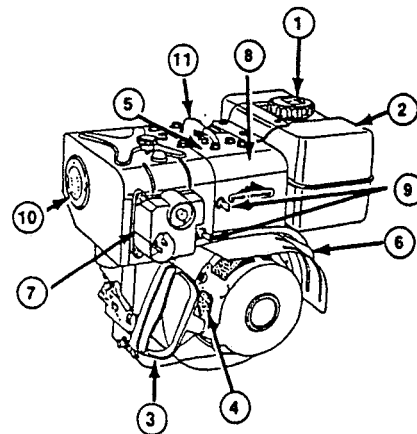
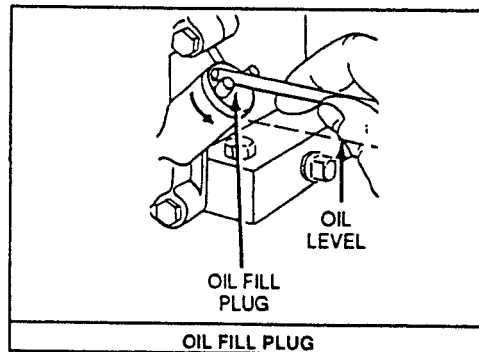

- | | |
|------------------------|---------------------------------|
| 1. FUEL FILL | 7. 120 VOLT STARTER (OPTIONAL) |
| 2. FUEL TANK | 8. MODEL, TYPE AND CODE NUMBERS |
| 3. REWIND STARTER | 9. KEY SWITCH |
| 4. ROTATING SCREEN | 10. MUFFLER |
| 5. SPARK PLUG WIRE TAB | 11. SPARK PLUG |
| 6. 12V STARTER MOTOR | |



FUEL RECOMMENDATIONS

This engine will operate satisfactorily on any gasoline intended for automotive use. A minimum of 77 octane is recommended. **DO NOT MIX OIL WITH GASOLINE.**

Use clean, fresh, lead-free gasoline. Leaded gasoline may be used if lead-free is not available. Use of lead-free gasoline results in fewer combustion deposits and longer valve life. We recommend the use of Briggs & Stratton Gasoline Additive, part no. 5041. Purchase fuel in quantity that can be used within 30 days. This will assure fuel freshness and volatility tailored to the season.

NOTE: We **DO NOT** recommend the use of gasoline which contains alcohol, such as gasohol. However, if gasoline with alcohol is used, it **MUST NOT** contain more than 10 percent Ethanol and **MUST** be removed from the engine during storage. **DO NOT** use gasoline containing Methanol. See **STORAGE INSTRUCTIONS.**



DO NOT FILL fuel tank to point of overflowing. Allow approximately 1/4 in. (5 mm) of tank space for fuel expansion.

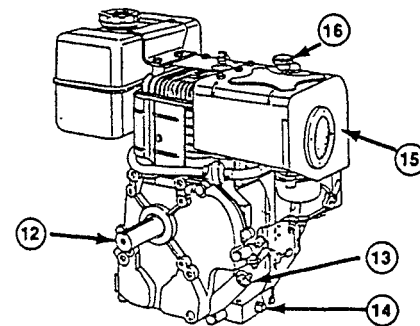

- | | |
|--------------------|--------------------------|
| 12. CRANKSHAFT | 15. HOOD OVER CARBURETOR |
| 13. OIL FILL PLUG | 16. THROTTLE CONTROL |
| 14. OIL DRAIN PLUG | |

Starting

TO START ENGINE:



WARNING: ALWAYS KEEP HANDS AND FEET CLEAR OF ROTATING MACHINERY.

TIPS TO OBTAIN BEST STARTING

1. Start, store and fuel engine in a level position.
2. DO NOT use a pressurized starting fluid. Severe engine damage may occur because of loss of lubrication.
3. A warm engine requires less choking than a cold engine.
4. De-clutch all possible external loads.
5. A slightly richer fuel mixture will usually improve cold starting. Turn idle mixture valve 1/8 turn counterclockwise.

COLD WEATHER STARTING HINTS

1. Use correct oil for temperature expected.
2. Set speed control at part throttle position.
3. A warm battery has much more starting capacity than a cold battery.
4. Do not use gasoline left over from summer. Use fresh winter grade fuel which has higher volatility to improve starting.

FUEL SHUT-OFF VALVE:

Turn valve several turns counterclockwise to open, on engines so equipped

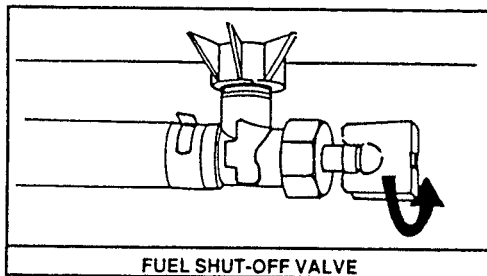

CHOKE ENGINE:



Move engine choke control as illustrated.

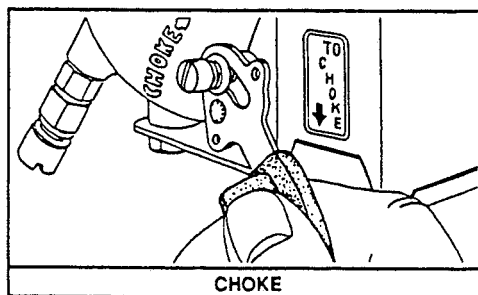

NOTE: If fuel drips out of carburetor while trying to start engine, engine is over-choked. Pull rewind starter handle several times or engage electric starter briefly to crank engine with choke open.

OIL GARD® (Optional Accessory)

OIL GARD® light warns of low oil level. If light flickers or remains on and if engine cannot be started or stopped and cannot be restarted, oil must be added. Fill to FULL mark on dipstick or to overflowing at oil fill plug. Do not over-fill.

STOP SWITCH:

Insert key in Switch, if so equipped.

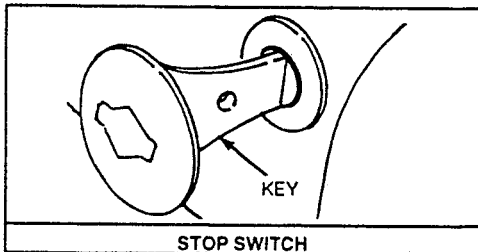

SET THROTTLE CONTROL:

MANUAL CONTROL: Pull engine throttle control knob as illustrated.

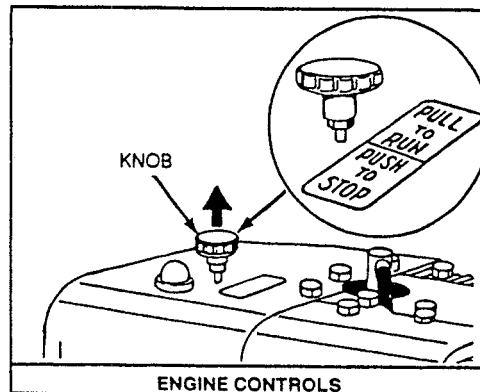

REMOTE CONTROL: Move equipment throttle control lever to "RUN," "FAST" OR "START" position.

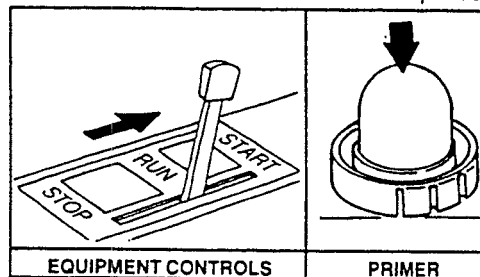

PRIME ENGINE:

To prime engine, push primer twice.

NOTE: When starting engine for first time or engine has been in storage with a dry fuel system, push primer until it becomes firm. Then push primer twice.

Starting & Stopping

REWIND STARTER

 Grasp starter grip as illustrated and pull slowly until resistance is felt. Then pull cord rapidly to overcome compression, prevent kickback and start engine. Repeat if necessary with choke opened slightly. When engine starts, open choke gradually.

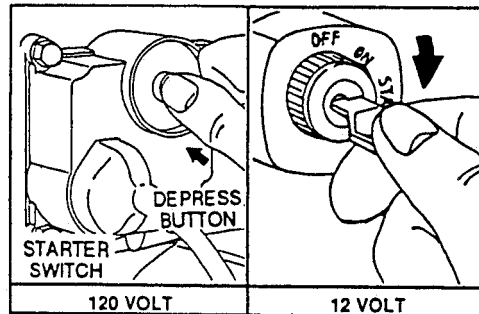
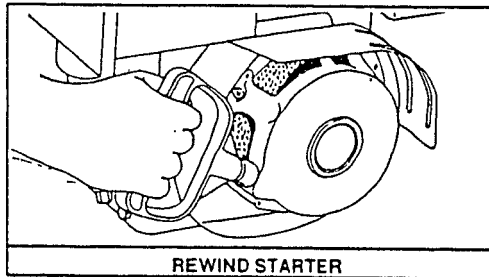

 **CAUTION:** The 120 volt electric starter is equipped with a three-prong plug for your safety. The longer prong in this plug is connected to the starter motor housing. When the starter motor is plugged into a properly grounded receptacle, it will protect the user from shock should the starter motor insulation fail for any reason. If a longer extension cord is used with this starter, it should also have three-prong and three-hole plugs.

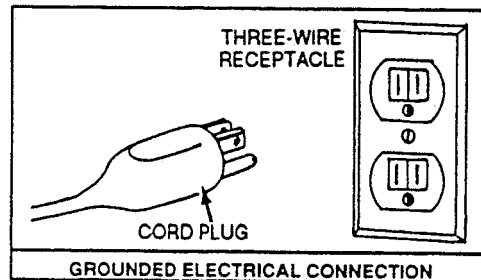

ELECTRIC STARTER

On engines equipped with 12 volt starting systems, turn key to "START" position or press starter button. On engines equipped with 120 volt starting systems, press "ON" button of conductor cord's integral "ON-OFF" switch. The best starter life is provided by using short starting cycles of several seconds. Prolonged cranking (more than 15 seconds per minute) damage the starter motor. Allow starter to cool $\frac{1}{2}$ minutes. Release as soon as engine starts and gradually open choke.

NOTE: Battery is supplied by equipment manufacturer and may require charging before use.

TO STOP ENGINE:

 Move equipment control to "SLOW" and then "STOP" position. Turn key to "OFF" position, if so equipped. Do not choke carburetor to stop engine. Backfire or engine damage may result if carburetor is used to stop engine.

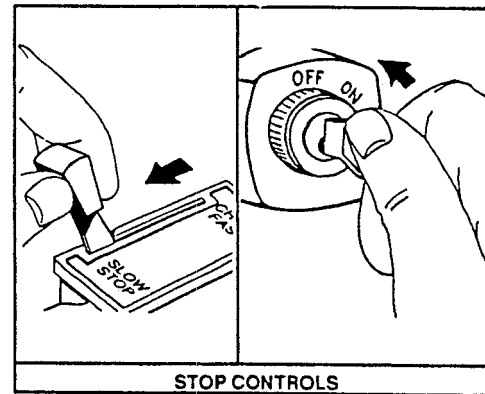

 **CAUTION:** Always remove key from switch when leaving equipment unattended or when equipment is not in use.

Adjustments

ENGINE AND EQUIPMENT CONTROLS



CAUTION: The manufacturer of the equipment on which the engine is installed specifies the Top No-Load RPM at which the engine will be operated. DO NOT EXCEED this RPM.

Correct control adjustment is necessary for good engine performance.

MANUAL FRICTION CONTROL

Move knob as shown to change engine speed.

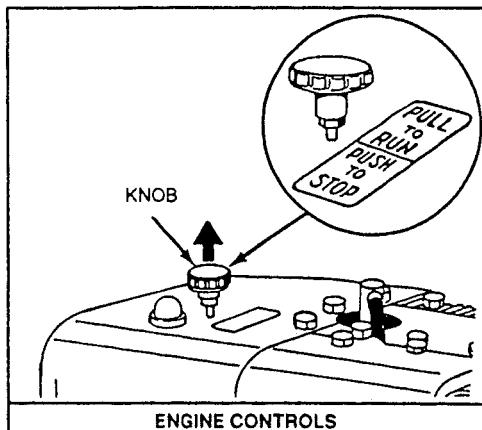

REMOTE CONTROL

Remote control casing and wire "B" are attached to engine at control plate as shown.

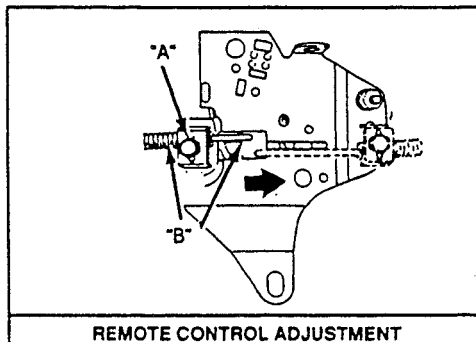

TO ADJUST OPERATION OF REMOTE CONTROL:

If adjustment is needed, move equipment control lever to "FAST" position. Loosen casing clamp screw "A" and move casing and wire "B" to end of travel in direction shown by arrow. Tighten casing clamp screw "A." Check operation of controls after adjustment. Readjust if necessary.

CARBURETOR ADJUSTMENTS

Minor carburetor adjustment may be required to compensate for differences in fuel, temperature, altitude or load. Sno/Gard hood must be assembled to carburetor when running engine.

NOTE: Make FINAL ADJUSTMENT at temperatures in which engine operates.

INITIAL ADJUSTMENT:

Gently turn valves clockwise until they just close. Valves may be damaged by turning them in too far.

Now open needle valve 1-1/2 turns counterclockwise and idle mixture valve 1 turn counterclockwise. This initial adjustment will permit the engine to be started and warmed up (approximately 5 minutes) prior to final adjustment.

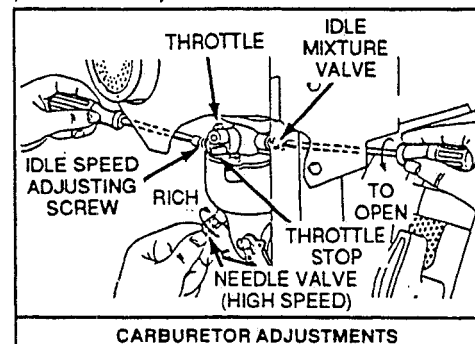

FINAL ADJUSTMENT:

Place equipment control lever in "FAST" position. Turn needle valve in until engine slows (clockwise - lean mixture). Then turn it out past smooth operating point until engine runs unevenly (rich mixture). Now turn needle valve to the midpoint between rich and lean so the engine runs smoothly.

Next, adjust idle RPM. Rotate throttle counterclockwise and hold against stop while adjusting idle speed adjusting screw to obtain 1750 RPM. Then while holding throttle against throttle stop, turn idle mixture valve in (lean) and out (rich). Set midway between rich and lean. Recheck idle RPM. Release throttle. Engine should accelerate smoothly. If it does not, the carburetor should be readjusted, usually to a slightly richer mixture.

Maintenance



CAUTION: TO PREVENT ACCIDENTAL STARTING when servicing the engine or equipment, always remove the wire from the spark plug and insert in holding tab. Disconnect negative wire from battery terminal, if equipped with 12 volt starting system.



CHECK OIL LEVEL REGULARLY: Check after each 5 hours of operation or daily. BE SURE OIL LEVEL IS MAINTAINED.

GENERAL RECOMMENDATIONS

Occasionally place a few drops of oil on governor and throttle linkage and choke. A slight film of oil on these parts will afford additional protection from freezing and corrosion.

After using snow removal equipment, continue to run the engine for about 10 minutes in an area protected from snow. This will give the engine an opportunity to dry out any moisture which has collected.

When equipment is not in operation, provide protection from direct exposure to freezing rain or snow.

CHANGE OIL AS RECOMMENDED:

Change oil after first 5 hours of operation. Then, under normal operating conditions, change oil after every 50 hours of operation or every season, whichever occurs first. Change oil after every 25 hours of operation if the engine is operated under heavy load. Remove oil drain plug and drain oil while engine is warm. Replace drain plug. Remove oil fill plug or dipstick and refill with new oil of correct grade. Replace oil fill plug or dipstick.

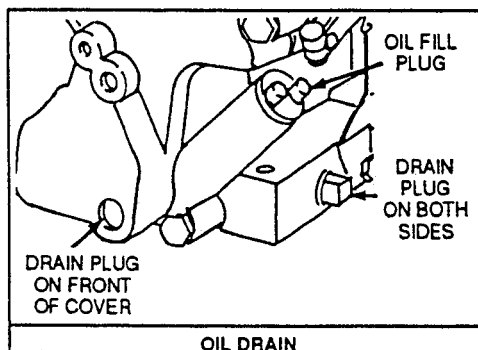

CHANGE OIL (Gear Reduction Option):

Remove oil level plug and oil fill plug. Drain oil after every 100 hours of operation or every season, whichever occurs first. To refill, pour SAE 30 oil into oil fill hole until it runs out level check hole. Replace both plugs. Oil fill plug has a vent hole and must be installed on top of gear case cover.

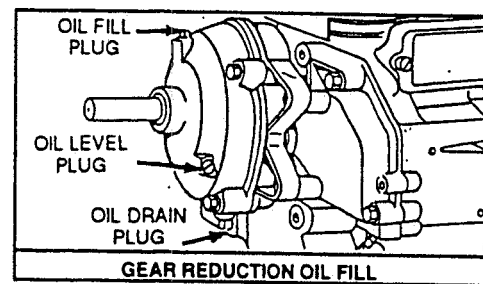

Maintenance

CLEAN ENGINE:

Remove dirt and debris with a cloth or brush. Cleaning with a forceful spray of water is not recommended as water could contaminate the fuel system.



CAUTION: To assure smooth operation, keep rack and pinion controls, governor linkage and springs free of debris.



CAUTION: Periodically clean muffler area to remove all dirt and combustible debris.

REPLACE FUEL FILTER:

Replace In-Line fuel filter every 100 hours or every season, whichever occurs first. Contact any Briggs & Stratton Authorized Service Center for correct replacement.

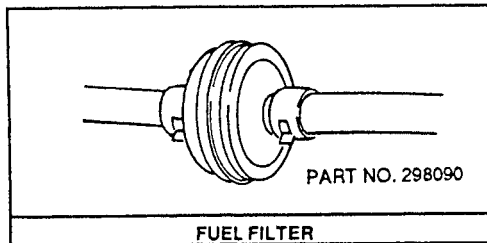

REPLACE OR CLEAN SPARK PLUG:

Replace or clean after every 100 hours of operation or every season, whichever occurs first.

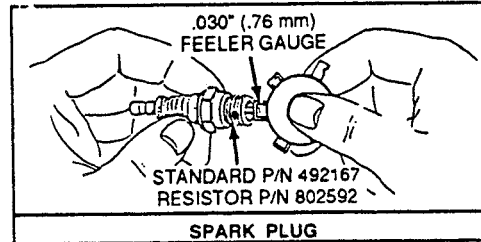

NOTE: Do not blast clean spark plug. Spark plug should be cleaned by scraping or wire brushing and washing with a commercial solvent.



CAUTION: Sparking can occur if wire terminal does not fit firmly on spark plug. Reform terminal if necessary.

CLEAN SPARK ARRESTER SCREEN:

If engine muffler is equipped with spark arrester screen assembly, remove every 50 hours or every season, whichever occurs first, for cleaning and inspection. Replace if damaged. Contact any Briggs & Stratton Authorized Service Center.

REMOVE COMBUSTION DEPOSITS:

Remove cylinder head every 100-300 hours of operation. Scrape and wire brush the combustion deposits from cylinder, cylinder head, top of piston and around valves. Reassemble gasket and cylinder head. Turn screws down finger tight with three longer screws around exhaust valve, if so equipped. Torque cylinder head screws in a staggered sequence to 165 in.-lbs. (19 Nm).

Maintenance Schedule

Follow the hourly or calendar intervals, whichever occur first. More frequent service may be required.

MAINTENANCE OPERATION	Every 5 Hours or Daily	25 Hours or Every Season	50 Hours or Every Season	100 Hours or Every Season	100-300 Hours
Check Oil Level	●				
Change Oil ♦			● Note 1		
Change Oil (Gear Reduction)				●	
Clean Cooling System				● Note 2	
Inspect Spark Arrestor (Optional Accessory)			●		
Replace or Clean Spark Plug				●	
Replace In-Line Fuel Filter				●	
Clean Combustion Chamber Deposits					●

- ♦ Change oil after first 5 hours, then after every 50 hours or every season.
- Note 1: Change oil every 25 hours when operating under heavy load or in high ambient temperatures.
- Note 2: Clean more often under dusty conditions or when airborne debris is present.

BRIGGS & STRATTON AUTHORIZED SERVICE CENTERS ARE READY TO SERVE YOU AND ARE COMMITTED TO QUALITY SERVICE.

International Symbols



..... Read Operator's Manual



..... Caution



..... Oil



..... Fuel



..... Choke



..... Fast



..... Slow



..... Air Cleaner

General Information

This is a single cylinder, L-head, air-cooled engine. On mobile equipment, the engine will operate satisfactorily at any angle at which operator and equipment can function safely.

MODEL SERIES 170400

Bore 3 in. (76.20 mm)
 Stroke 2-3/8 in. (60.33 mm)
 Displacement 16.79 cu. in. (275.1 cc)
 Torque (Max.) 11.0 Ft.-Lbs. @ 2600 RPM

MODEL SERIES 190400

Bore 3 in. (76.20 mm)
 Stroke 2-3/4 in. (69.85 mm)
 Displacement 19.44 cu. in. (318.5 cc)
 Torque (Max.) 12.7 Ft.-Lbs. @ 2500 RPM

NOTE: Engine power will decrease 3-1/2% for each 1,000 feet (305 m) above sea level and 1% for each 10° F (5.6° C) above 60° F (16° C).

TUNE-UP SPECIFICATIONS

DESCRIPTION	B & S PART NO.
Fuel Filter	298090
Standard Spark plug	492167 (Champion J19LM)
Resistor Spark plug	802592 (Champion RJ19LM)

CLEARANCES

	DIMENSION
Spark Plug Gap030 in. (.76 mm)
Intake Valve*005-.007 in. (.13-.18 mm)
Exhaust Valve*009-.011 in. (.23-.28 mm)

* with valve springs installed and piston 1/4 in. (6 mm) past top dead center.

In some areas, local law requires the use of a resistor spark plug to suppress ignition signals. If an engine was originally equipped with a resistor spark plug, be sure to use the same type of spark plug for replacement.

Note Walking fingers logo and "Yellow pages" are registered trademarks in various jurisdictions.

STORAGE INSTRUCTIONS

Engines to be stored over 30 days need to be protected or drained of fuel to prevent gum from forming in the fuel system or on essential carburetor parts.

1. For engine protection, we recommend the use of Briggs & Stratton Gasoline Additive, Part No. 5041, available from any Briggs & Stratton Authorized Service Center. Mix Additive with fuel in fuel tank or storage container. Run engine for a short time to circulate Additive through carburetor. Engine and fuel can be stored up to 24 months.



CAUTION: If Additive is not used or if engine is operating on gasoline containing alcohol, remove all fuel from tank and run engine until it stops from lack of fuel.

2. While engine is still warm, drain oil from crankcase. Refill with fresh oil.
3. Remove spark plug and pour approximately 1/2 ounce (15 ml) of engine oil into the cylinder. Replace spark plug and crank slowly to distribute oil.
4. Clean dirt and chaff from cylinder, cylinder head fins, blower housing, rotating screen and muffler areas.
5. Store in a clean and dry area.

SERVICE & REPAIR INFORMATION

If service or repair is needed, contact a Briggs & Stratton Authorized Service Center. To serve you promptly and efficiently, a Service Center will need model, type and code numbers from your engine.



Your nearest service center may be located in the "Yellow Pages"™ directory under "Engines, Gasoline," "Gas Engines," or similar category. You can also locate the service center in your mailing zip code area by telephoning 1-800-233-3723. There are over 30,000 Authorized Service Centers worldwide available to serve you.

If service or repair is needed, contact a Briggs & Stratton Authorized Service Center. To serve you promptly and efficiently, a Service Center will need model, type and code numbers from your engine. Authorized Service Centers carry a stock of Original Briggs & Stratton Service Replacement Parts and are equipped with special service tools. Ask for Original Briggs & Stratton Service Replacement Parts which preserve the original design of your engine. Imitation replacement parts offer potential risks in internal construction as well as fit, finish and warranty back-up. Trained mechanics assure expert repair service on all Briggs & Stratton engines. Major engine repairs require proper tools and a thorough knowledge of internal combustion engine repair procedure.

Briggs & Stratton publishes illustrated shop manuals, parts lists and owner's manuals for every engine it manufactures. To receive a list of available publications, write to Briggs & Stratton Corporation, P. O. Box 1144, Milwaukee, WI 53201, Attention: Service Division.

The shop manual shown here includes "Theories of Operation," common specifications and detailed information covering the adjustment, tune-up and repair of Briggs & Stratton L-head, single cylinder, 4 cycle engines and is available from any Briggs & Stratton Authorized Service Center.



Part No. 270962

ABOUT YOUR ENGINE WARRANTY: (see back cover for statement of LIMITED WARRANTY.)

Briggs & Stratton welcomes warranty repair and apologizes to you for being inconvenienced. Any Authorized Service Dealer may perform warranty repairs. Most warranty repairs are handled routinely, but sometimes requests for warranty service may not be appropriate. For example, warranty would not apply if engine damage occurred because of misuse, lack of routine maintenance, shipping, handling, warehousing or improper installation. Similarly, warranty is void if the serial number of the engine has been removed or the engine has been altered or modified.

If a customer differs with the decision of the Service Dealer, an investigation will be made to determine whether the warranty applies. Ask the Service Dealer to submit all supporting facts to his Distributor or the Factory for review. If the Distributor or the Factory decides that the claim is justified, the customer will be fully reimbursed for those items that are defective. To avoid misunderstanding which might occur between the customer and the Dealer, listed below are some of the causes of engine failure that the warranty does not cover.

IMPROPER MAINTENANCE:

The life of an engine depends upon the conditions under which it operates, and the care it receives. Some applications, such as tillers, pumps and rotary mowers, are very often used in dusty or dirty conditions, which can cause what appears to be premature wear. Such wear, when caused by dirt, dust, spark plug cleaning grit, or other abrasive material that has entered the engine because of improper maintenance, is not covered by warranty.

THIS WARRANTY COVERS ENGINE RELATED DEFECTIVE MATERIAL AND/OR WORKMANSHIP ONLY, AND NOT REPLACEMENT OR REFUND OF THE EQUIPMENT TO WHICH THE ENGINE MAY BE MOUNTED. NOR DOES THE WARRANTY EXTEND TO REPAIRS REQUIRED BECAUSE OF:

1. PROBLEMS CAUSED BY PARTS THAT ARE NOT ORIGINAL BRIGGS & STRATTON PARTS.
2. Equipment controls or installations that prevent starting, cause unsatisfactory engine performance, or shorten engine life. (Contact equipment manufacturer.)
- Leaking carburetors, clogged fuel pipes, sticking valves, or other damage, caused by using contaminated or stale fuel. (Use clean,

fresh, lead-free gasoline and Briggs & Stratton gasoline stabilizer, Part No. 5041.)

4. Parts which are scored or broken because an engine was operated with insufficient or contaminated lubricating oil, or an incorrect grade of lubricating oil (4 cycle engines: check oil level daily or after every 8 hours of operation. Refill when necessary and change at recommended intervals.) (2 cycle engines: use correct mixture of gasoline and BIA/NMMA certified oil.) Read "Owner's Manual."
5. Repair or adjustment of associated parts or assemblies such as clutches, transmissions, remote controls, etc., which are not manufactured by Briggs & Stratton.
6. Damage or wear to parts caused by dirt, which entered the engine because of improper air cleaner maintenance, re-assembly, or use of a nonoriginal air cleaner element or cartridge. (At recommended intervals, clean and re-oil the Oil-Foam® element or the foam pre-cleaner, and replace the cartridge.) Read "Owner's Manual."
7. Parts damaged by overspeeding, or overheating caused by grass, debris, or dirt, which plugs or clogs the cooling fins, or flywheel area, or damage caused by operating the engine in a confined area without sufficient ventilation. (Clean fins on the cylinder, cylinder head and flywheel at recommended intervals.) Read "Owner's Manual."
8. Engine or equipment parts broken by excessive vibration caused by a loose engine mounting, loose cutter blades, unbalanced blades or loose or unbalanced impellers, improper attachment of equipment to engine crankshaft, overspeeding or other abuse in operation.
9. A bent or broken crankshaft, caused by striking a solid object with the cutter blade of a rotary lawn mower, or excessive v-belt tightness.
10. Routine tune-up or adjustment of the engine.
11. Engine or engine component failure, i.e., combustion chamber, valves, valve seats, valve guides, or burned starter motor windings, caused by the use of alternate fuels such as, liquified petroleum, natural gas, altered gasolines, etc.

WARRANTY IS AVAILABLE ONLY THROUGH SERVICE DEALERS WHICH HAVE BEEN AUTHORIZED BY BRIGGS & STRATTON CORPORATION. YOUR NEAREST AUTHORIZED SERVICE DEALER IS LISTED IN THE "YELLOW PAGES" OF YOUR TELEPHONE DIRECTORY UNDER "ENGINES, GASOLINE" OR "GASOLINE ENGINES," "LAWN MOWERS," OR SIMILAR CATEGORY.

Briggs & Stratton Engines Are Made Under One Or More Of The Following Patents: Design D-247,177 (Other Patents Pending)							
5,271,363	5,197,425	5,105,331	5,016,588	4,971,219	4,520,288	4,270,509	DES. 309,458
5,269,713	5,197,422	5,086,890	4,996,956	4,895,119	4,453,507	4,233,534	DES. 309,457
5,265,700	5,191,864	5,040,644	4,995,357	4,819,593	4,430,984	4,168,288	DES. 308,872
5,243,878	5,150,674	5,040,503	4,977,879	4,694,792	4,355,253	4,068,636	DES. 308,871

In the USA and Canada, a 24 hour hot line, 1-800-233-3723, has a menu of pre-recorded messages offering you engine maintenance information.

BRIGGS & STRATTON ENGINE OWNER WARRANTY POLICY

effective February 1, 1994
Replaces all undated Warranties and all Warranties
dated before February 1, 1994

LIMITED WARRANTY

"Briggs & Stratton Corporation will repair or replace, free of charge, any part, or parts of the engine that are defective in material or workmanship or both. Transportation charges on parts submitted for repair or replacement under this Warranty must be borne by purchaser. This warranty is effective for the time periods and subject to the conditions provided for in this policy. For warranty service contact your nearest Authorized Service Dealer as listed in the 'Yellow Pages™' under 'Engines, Gasoline,' 'Gasoline Engines,' 'Lawn Mowers' or similar category. THERE IS NO OTHER EXPRESS WARRANTY. IMPLIED WARRANTIES, INCLUDING THOSE OF MERCHANTABILITY AND FITNESS FOR A PARTICULAR PURPOSE ARE LIMITED TO ONE YEAR FROM PURCHASE, OR TO THE EXTENT PERMITTED BY LAW ANY AND ALL IMPLIED WARRANTIES ARE EXCLUDED. LIABILITY FOR CONSEQUENTIAL DAMAGES UNDER ANY AND ALL WARRANTIES ARE EXCLUDED TO THE EXTENT EXCLUSION IS PERMITTED BY LAW. Some states do not allow limitations on how long an implied warranty lasts, and some states do not allow the exclusion or limitation of incidental or consequential damages, so the above limitation and exclusion may not apply to you. This warranty gives you specific legal rights and you may also have other rights which vary from state to state."

Briggs & Stratton Corporation

F. P. Stratton, Jr.
Chairman and Chief Executive Officer

WARRANTY PERIOD

ENGINES	WITHIN U.S.A. AND CANADA		OUTSIDE U.S.A. AND CANADA	
	CONSUMER USE*	COMMERCIAL USE*	CONSUMER USE*	COMMERCIAL USE*
All Vanguard™ engines.	2 year - engine / Lifetime** - Magnetron® ignition			
All Diamond Plus, Europa™, Industrial Plus™ and all I/C®.	2 year	1 year	2 year	1 year
Quantum® and Diamond Power.	2 year	90 days	2 year †	90 days
All standard 2 through 18 HP engines installed on lawn mowers, riders, edgers, tillers, and all Sno/Gard engines.	2 year	90 days	1 year	90 days
All other standard 2 through 18 HP engines.	1 year	90 days	1 year	90 days

* For purposes of this warranty policy, "consumer use" means personal residential household use by the original retail consumer. "Commercial use" means all other uses, including use for commercial, income producing or rental purposes. Once an engine has experienced commercial use, it shall thereafter be considered as a commercial use engine for purposes of this warranty. **Engines used in competitive racing or on commercial rental tracks are not warrantied.**

** Lifetime limited warranty of the Magnetron® ignition covers parts and labor for the first five (5) years from the date of purchase; thereafter only parts. "Lifetime" means lifetime of the engine in the hands of the original purchaser.

† One (1) year in Australia and New Zealand.

**NO WARRANTY REGISTRATION CARD IS NECESSARY TO OBTAIN WARRANTY ON BRIGGS & STRATTON ENGINES.
YOU MUST SAVE THE PURCHASE RECEIPT. A PROOF OF PURCHASE DATE WILL BE REQUIRED TO OBTAIN WARRANTY.**